

/101

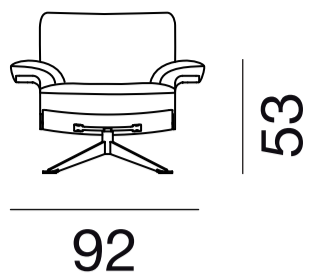

76

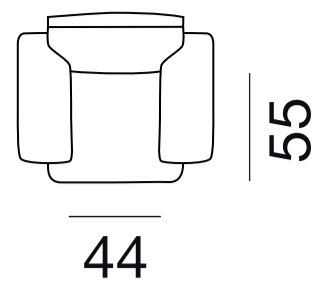
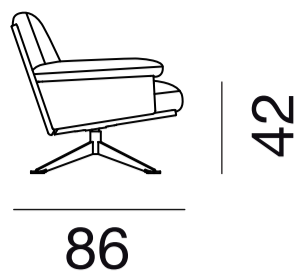

/102

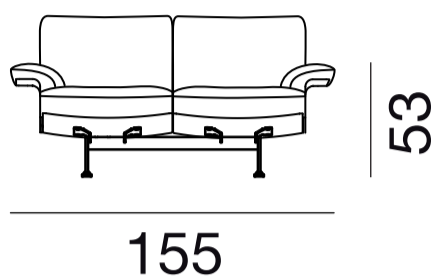

76

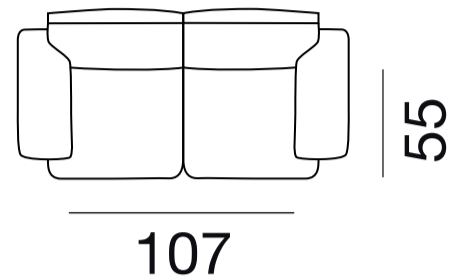
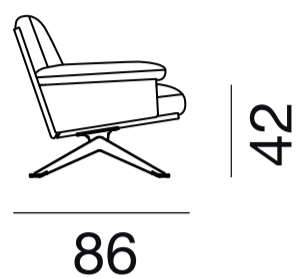

/103

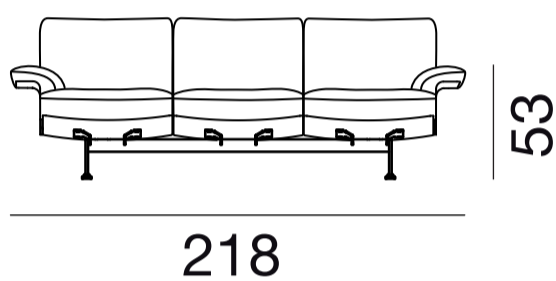

76

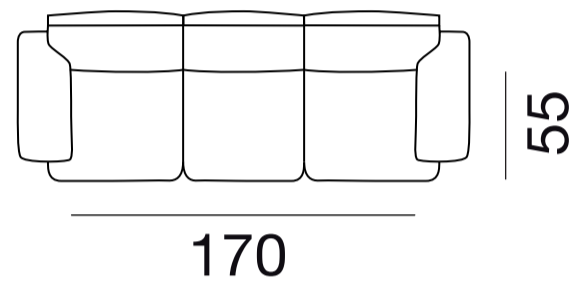
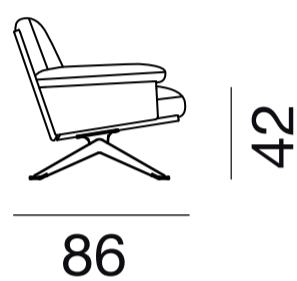

/111

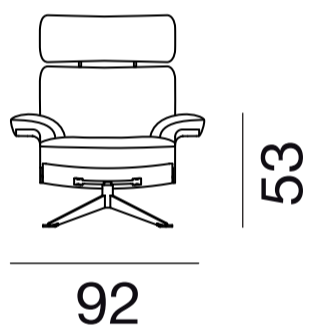

101

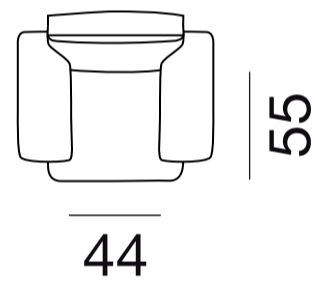
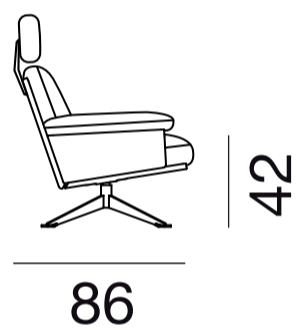

/112

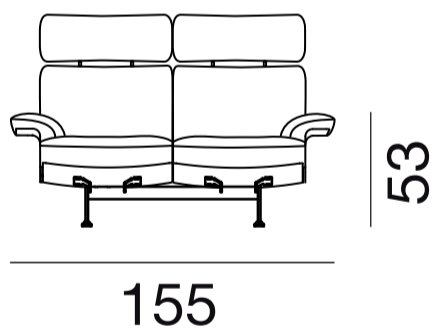

101

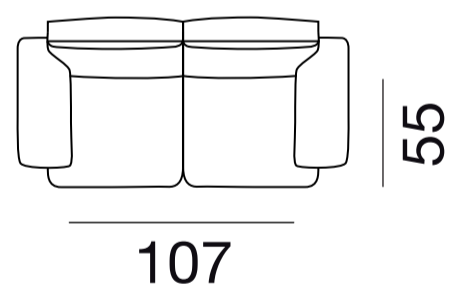
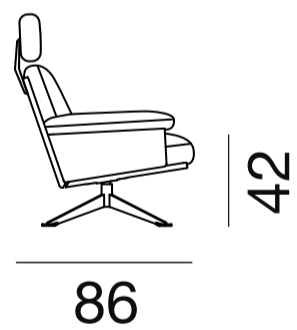

/113

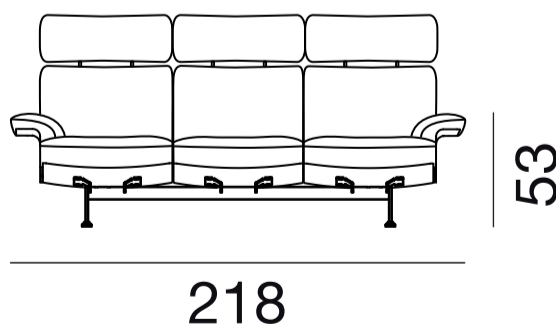

101

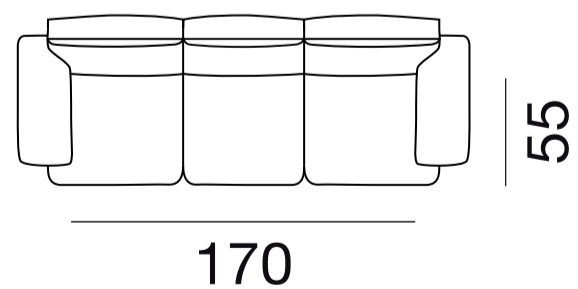
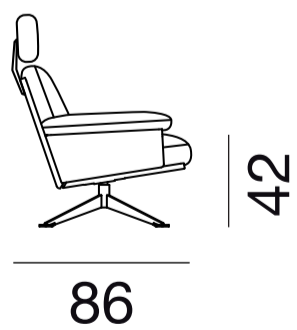

/105

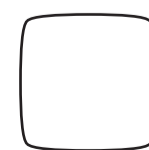
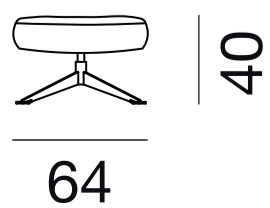

/101

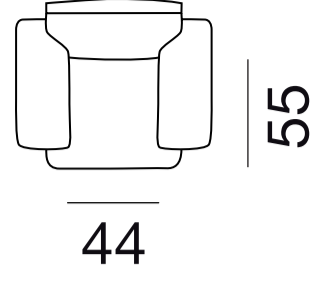
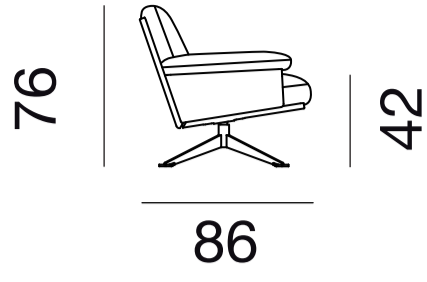
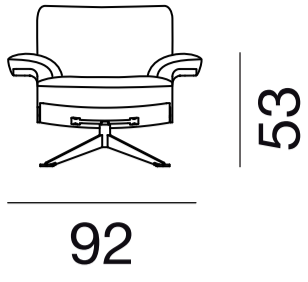

/102

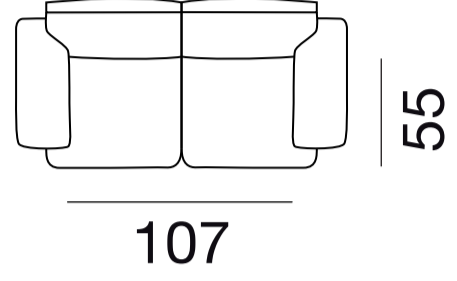
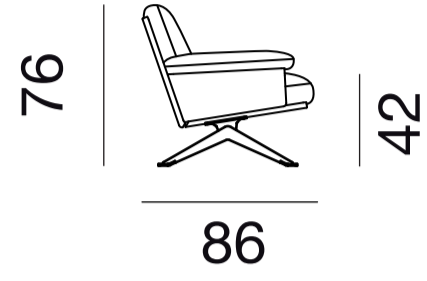
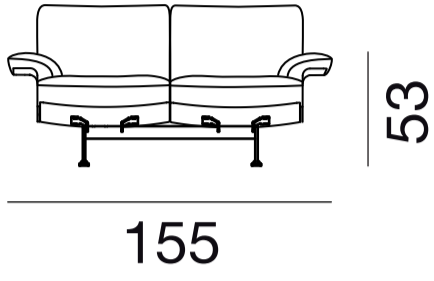

/103

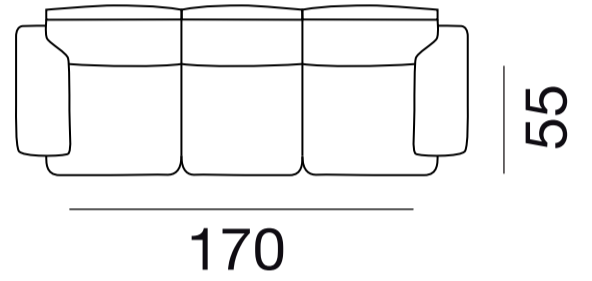
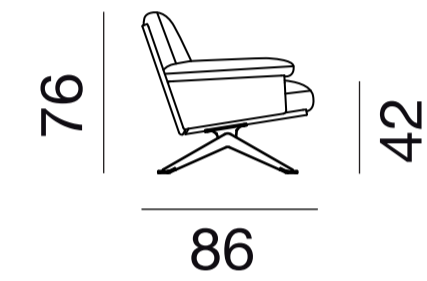
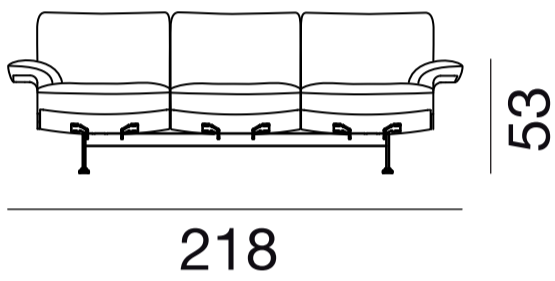

/111

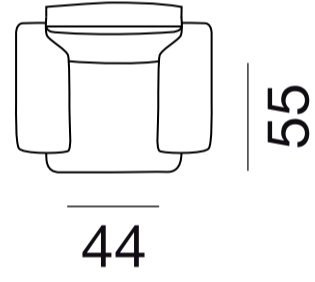
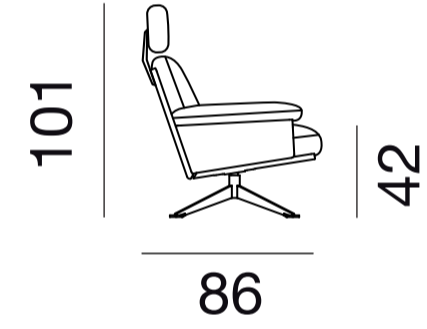
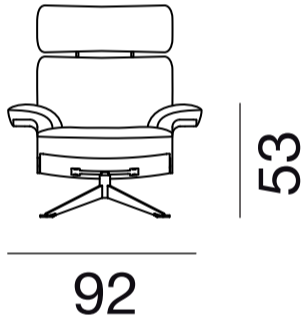

/112

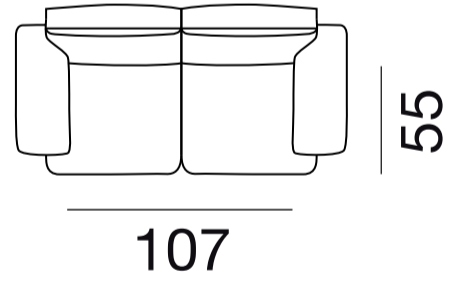
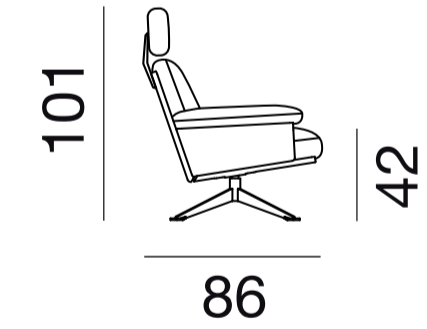
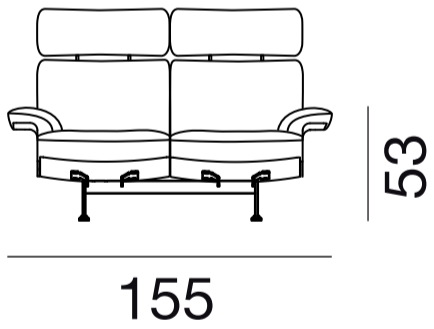

/113

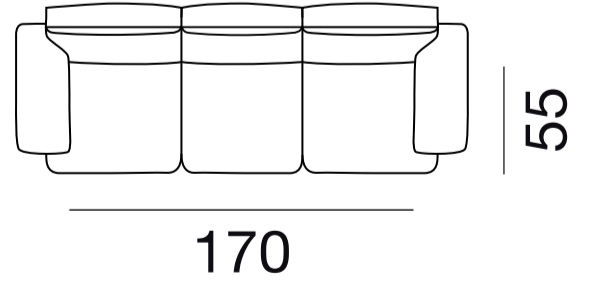
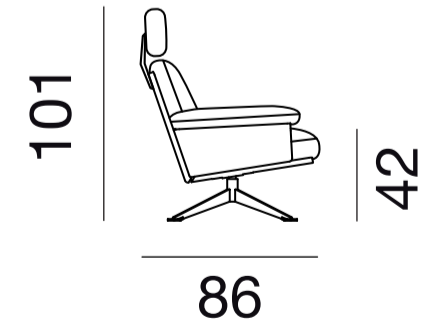
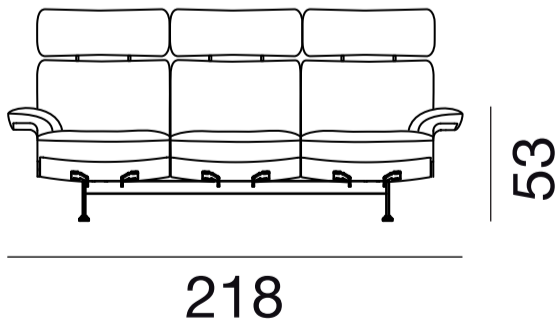

/105

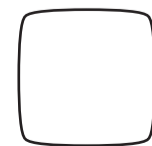
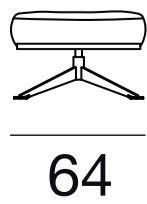
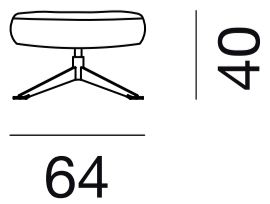



53

92

76



42

86

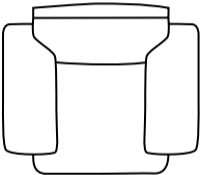

55

44

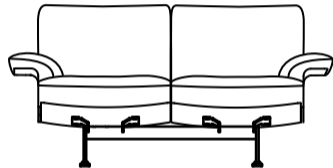

155

53

76



86

42

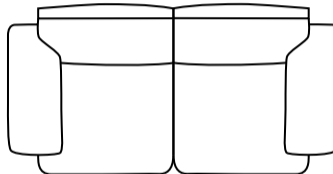

107

55

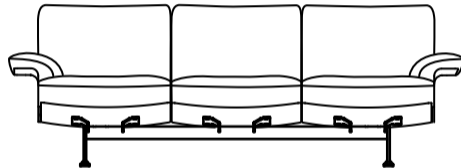

53

218

76



42

86

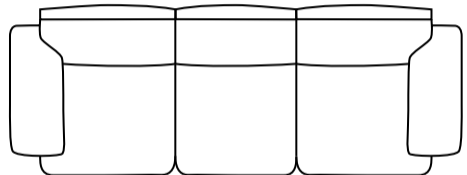

55

170

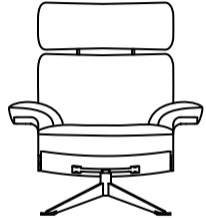

53

92

101



42

86

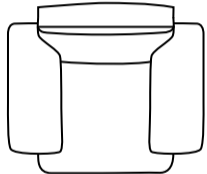

55

44

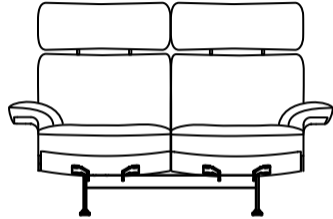

155

53

101



86

42

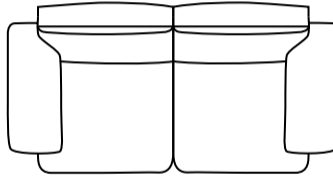

107

55

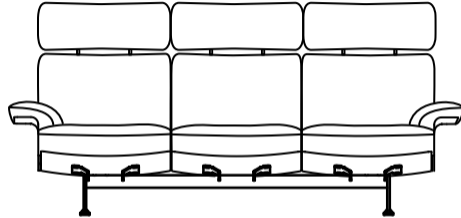

218

53

101



86

42

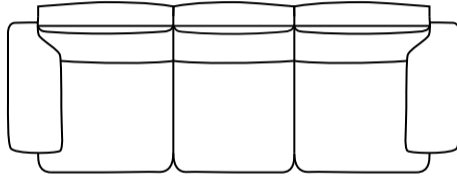

170

55



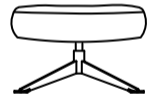

40



64

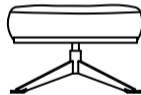

64

