

Sessel/Armchair

/06

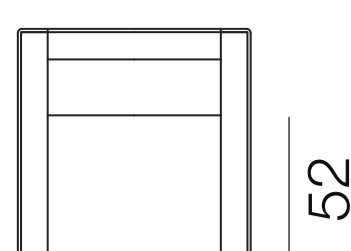
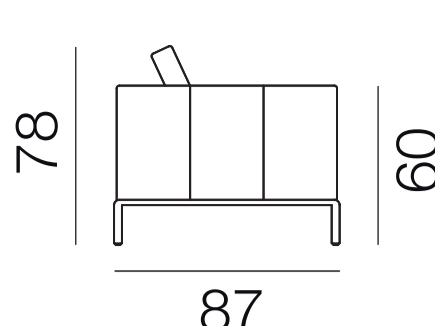
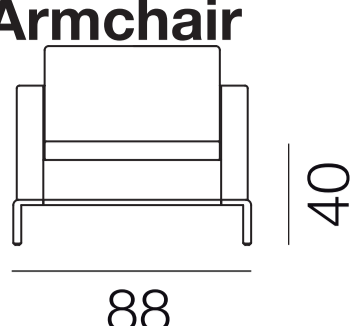

Sofa/Sofa

/02

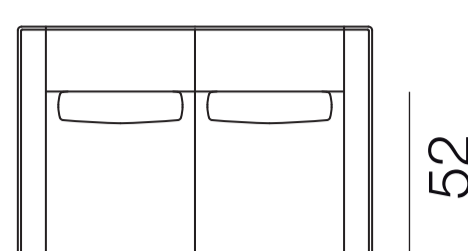
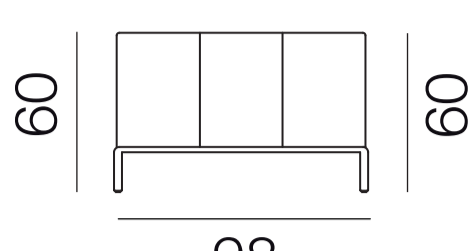
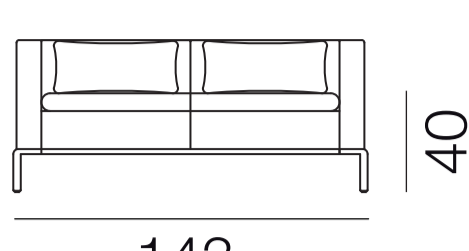

/03

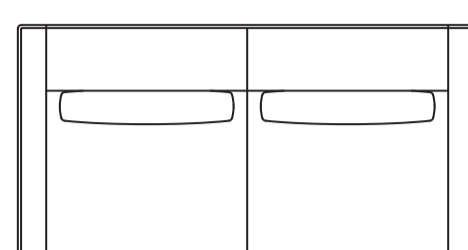
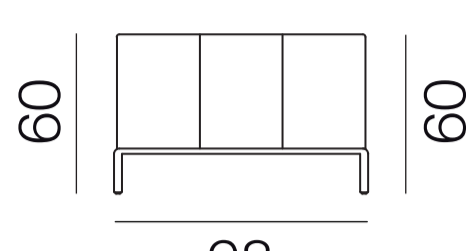
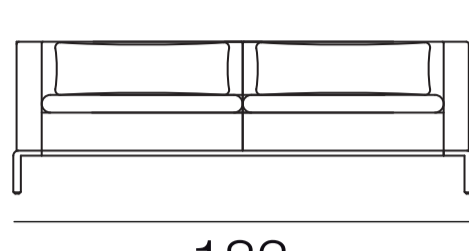

/04

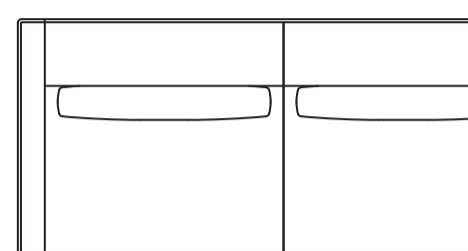
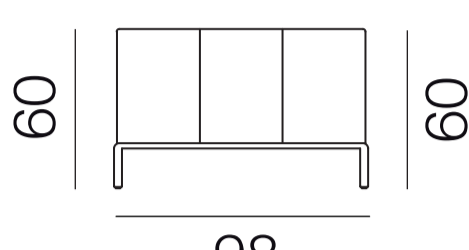
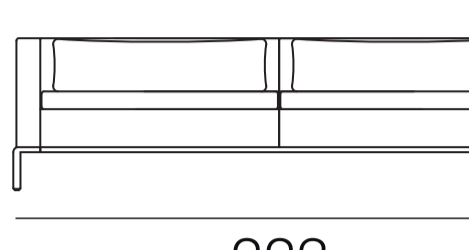

Abschlusselemente links/End elements left

/19

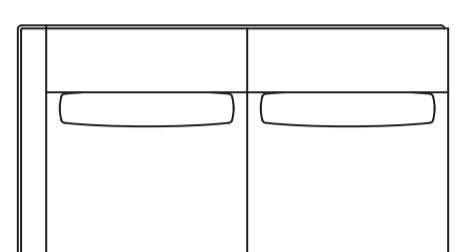
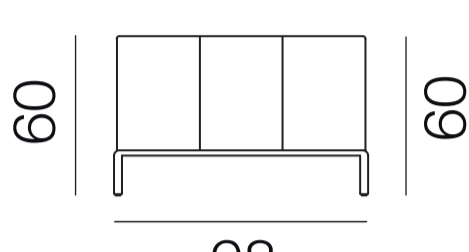
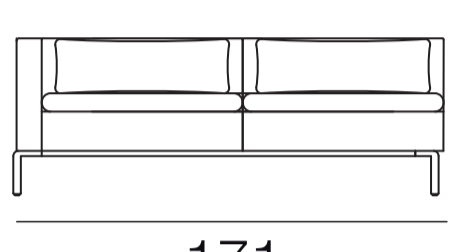

/29

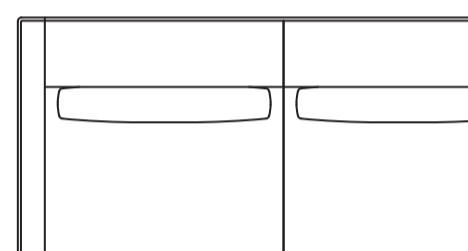
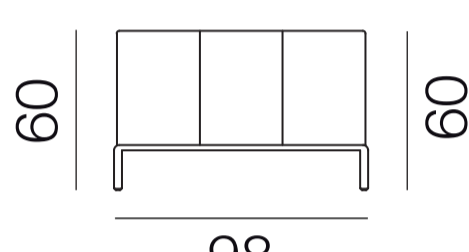
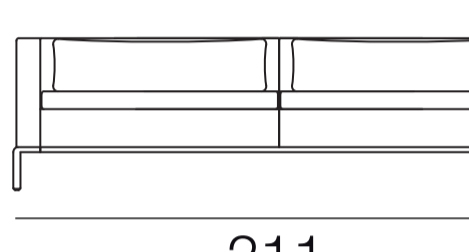

/59

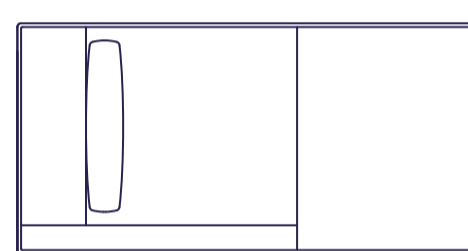
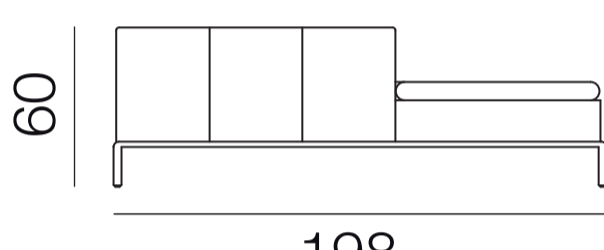
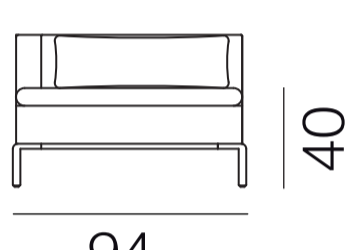

Abschlusselemente rechts/End elements right

/20

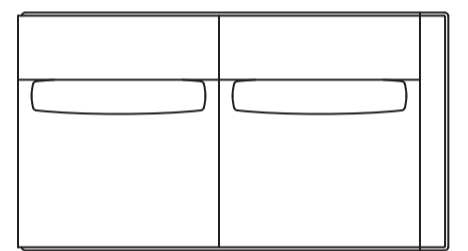
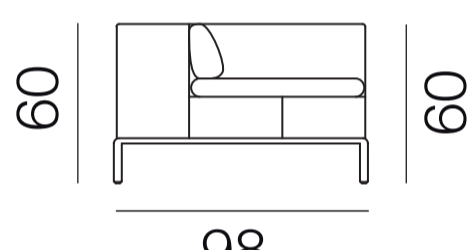
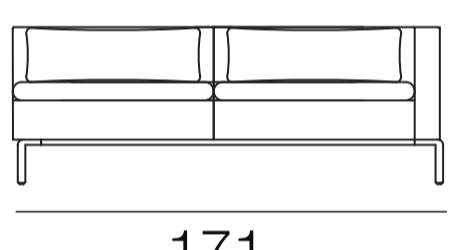

/30

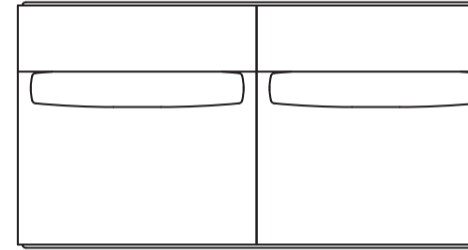
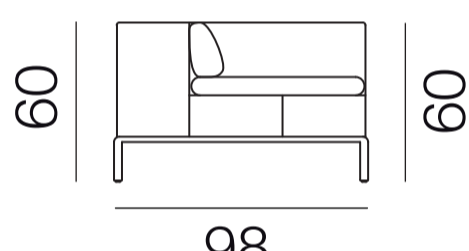
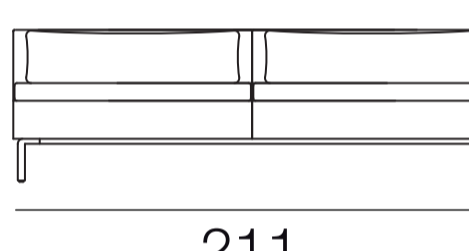

/60

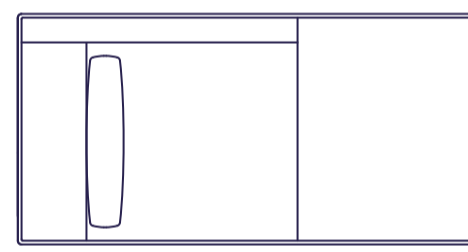
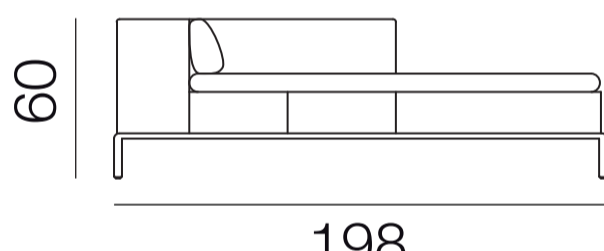
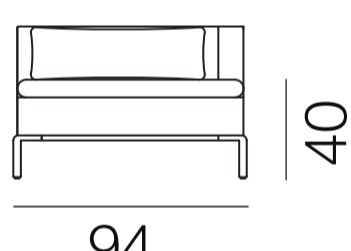

Anbauelemente/End elements

/79

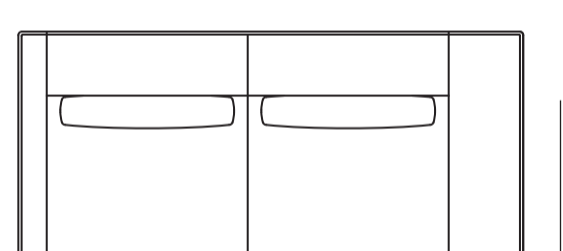
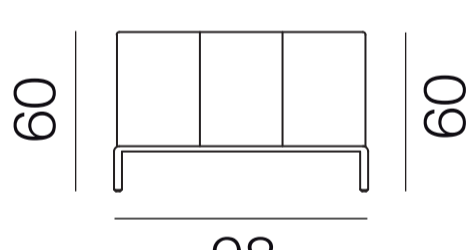
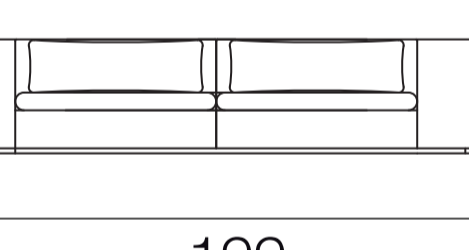

/89

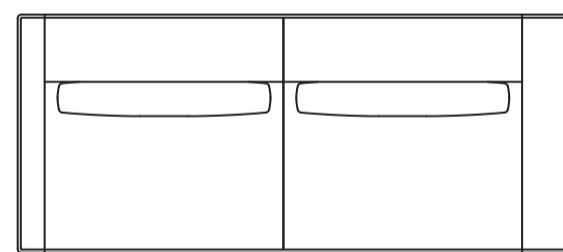
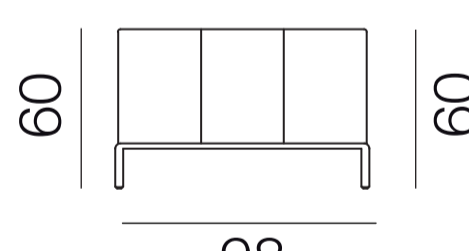
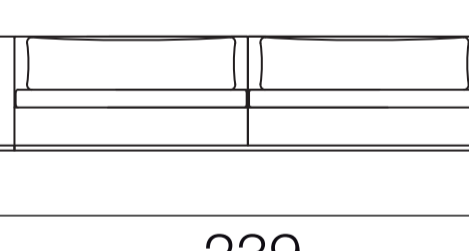

/80

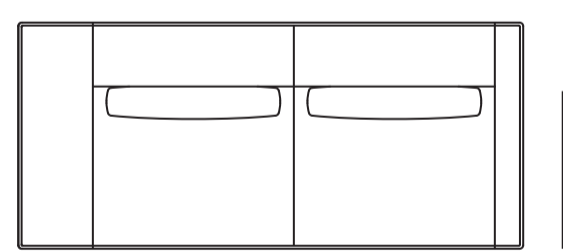
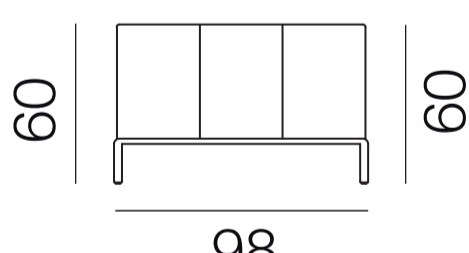
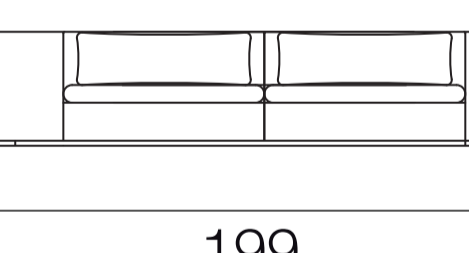

/90

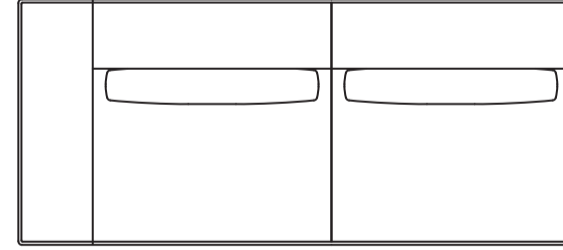
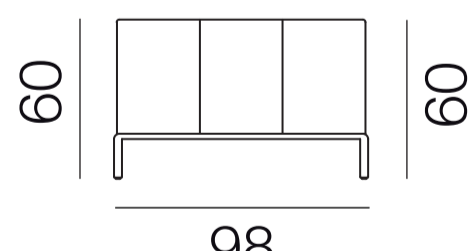
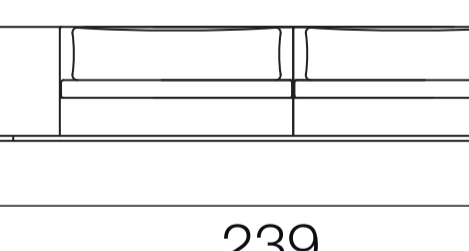

Hocker/Stool

/05

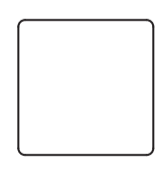
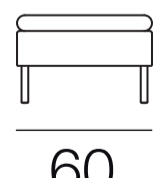
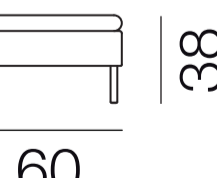

/35

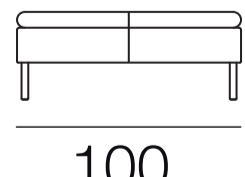
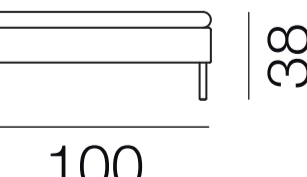

/45

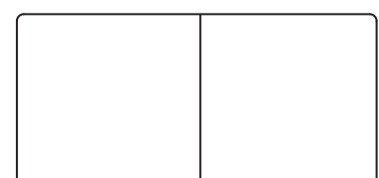
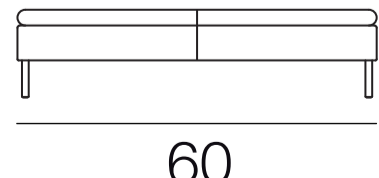
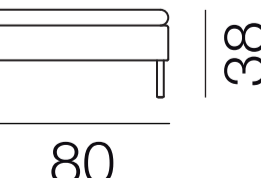

Kissen/Cushions

/98

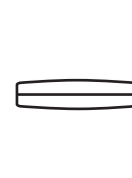
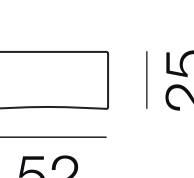

Sessel/Armchair

/06

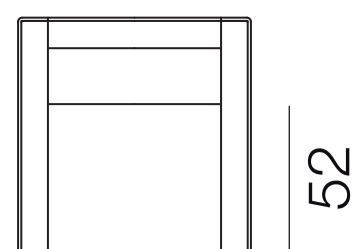
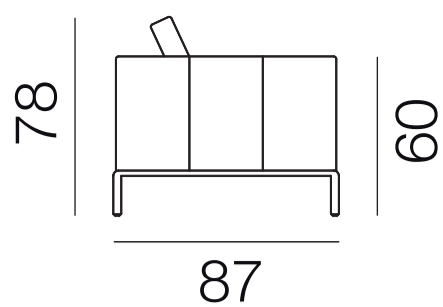
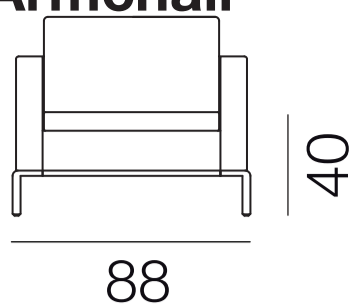

Sofa/Sofa

/02

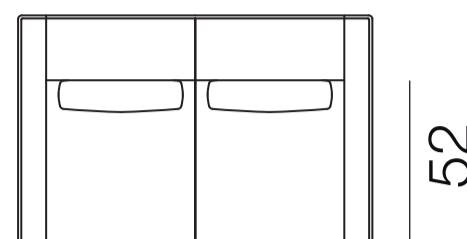
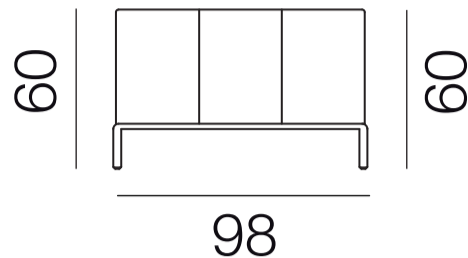
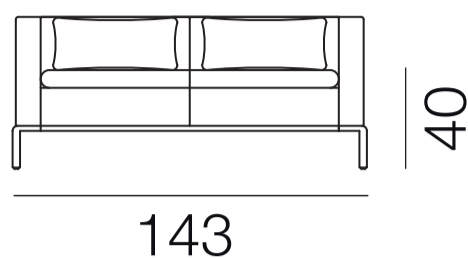

/03

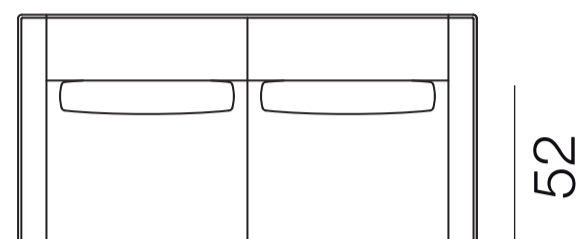
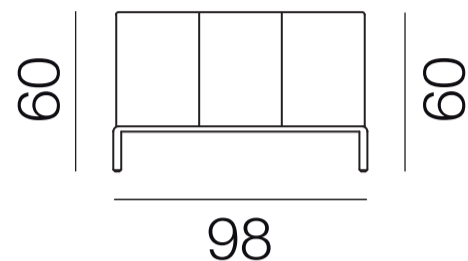
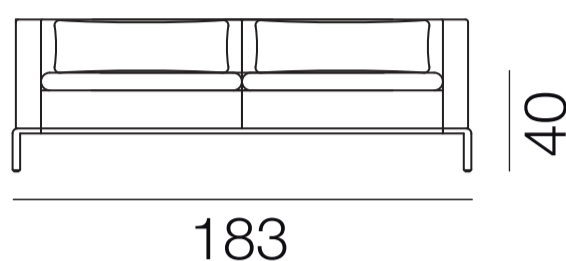

/04

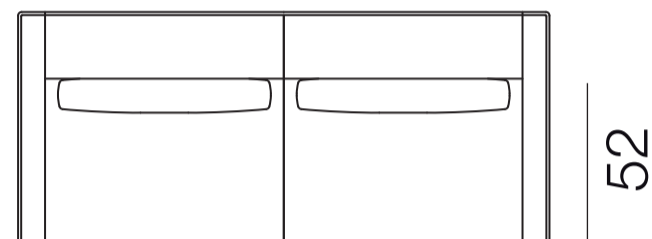
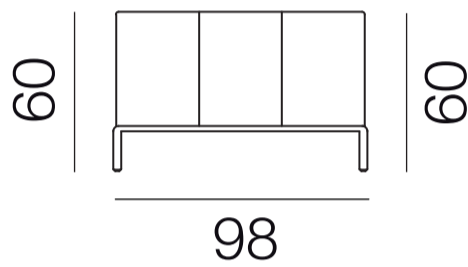
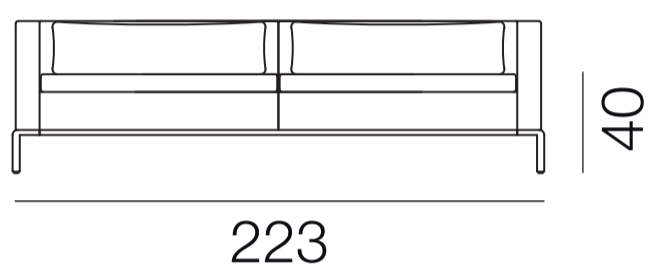

Abschlusselemente links/End elements left

/19

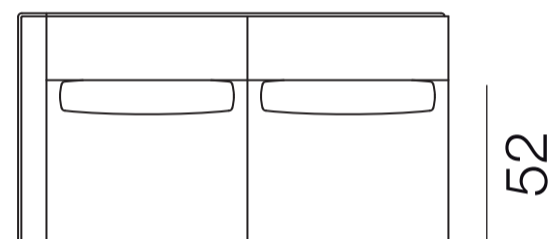
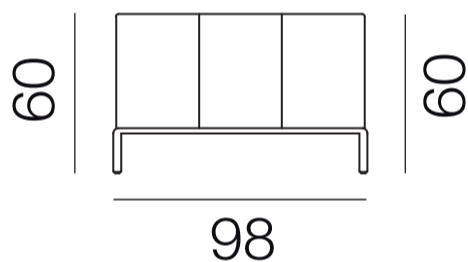
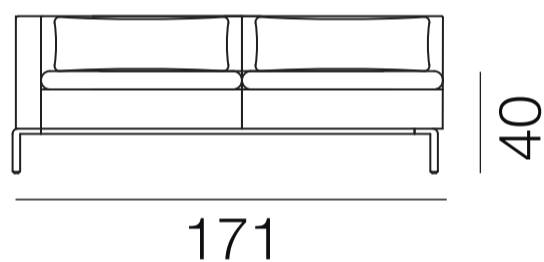

/29

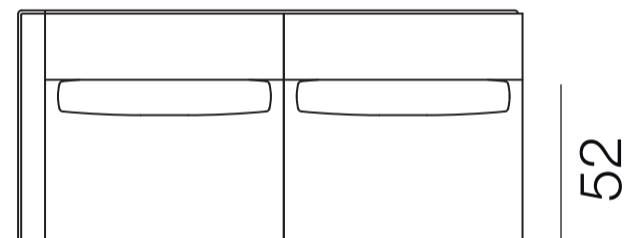
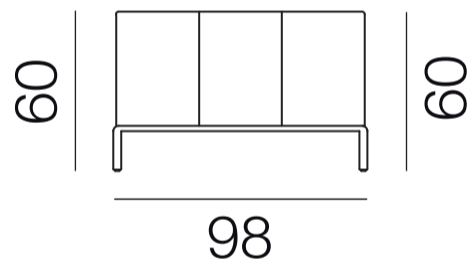
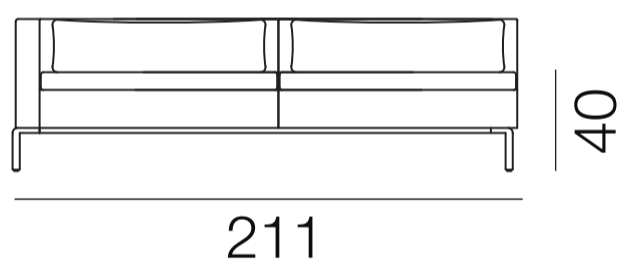

/59

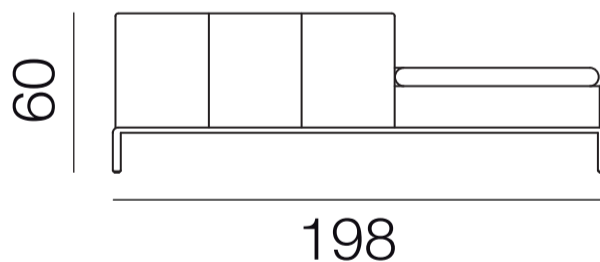
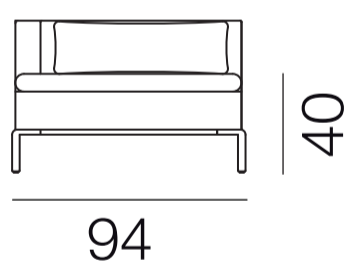

Abschlusselemente rechts/End elements right

/20

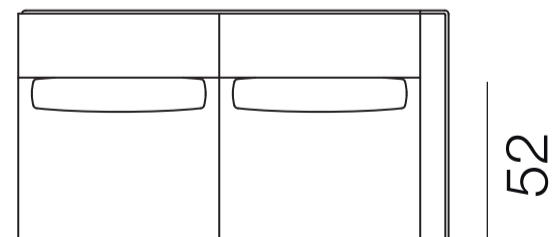
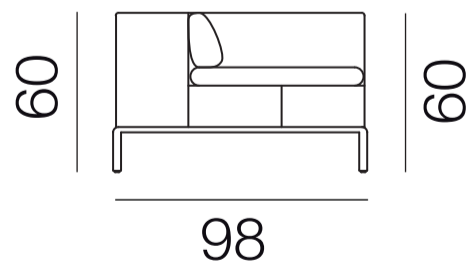
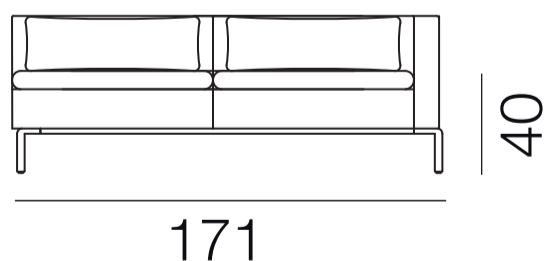

/30

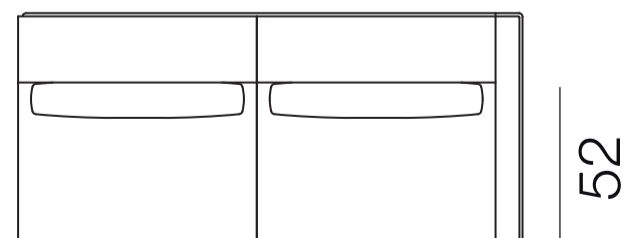
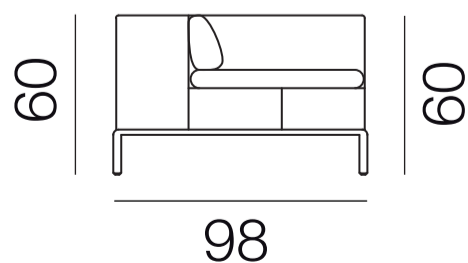
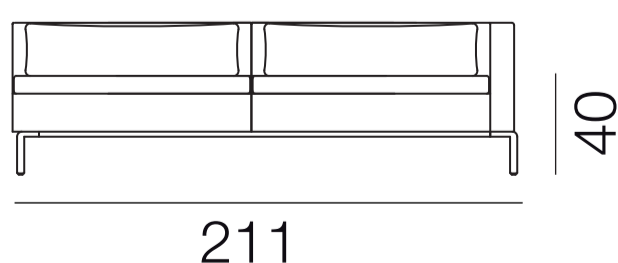

/60

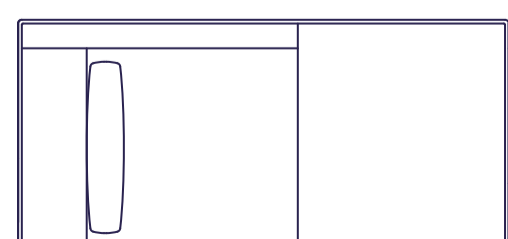
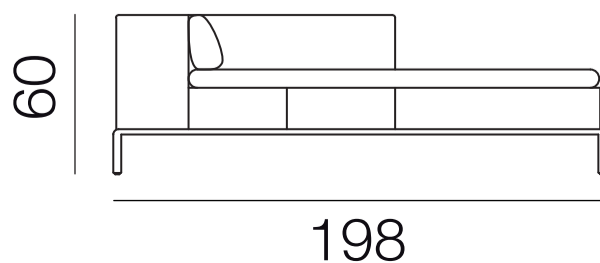
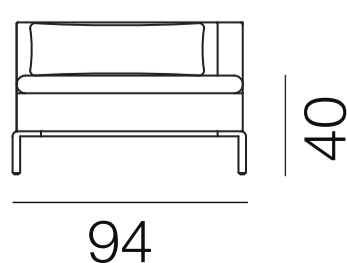

Anbauelemente / End elements

/79

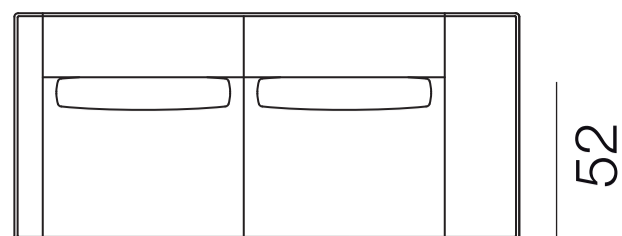
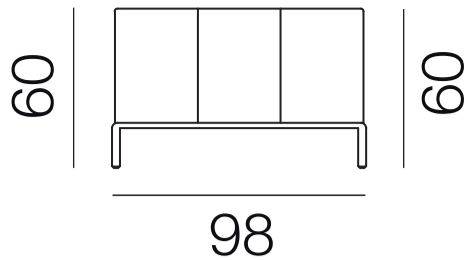
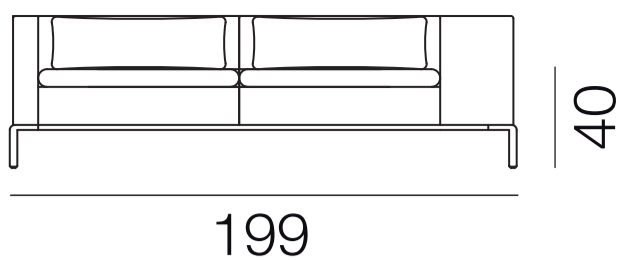

/89

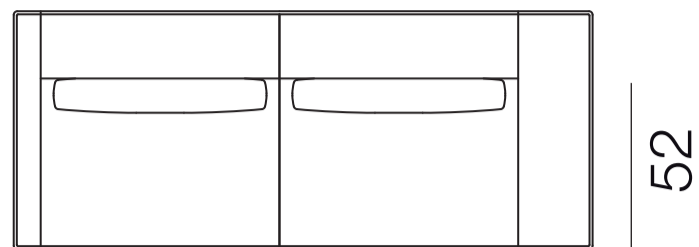
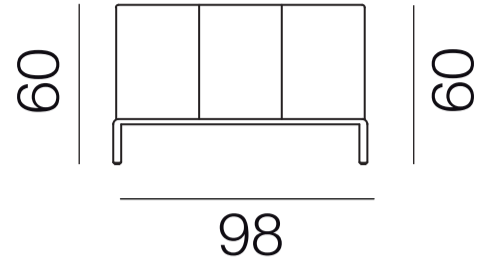
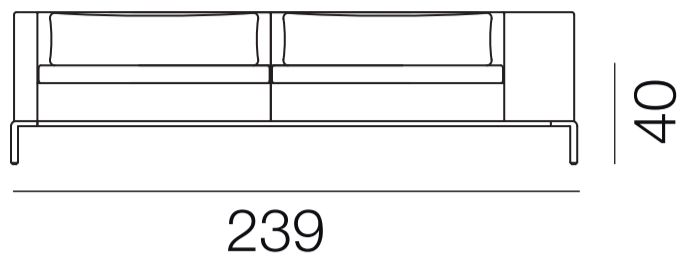

/80

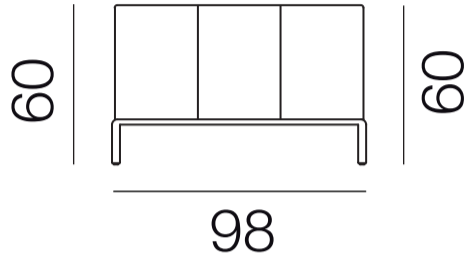
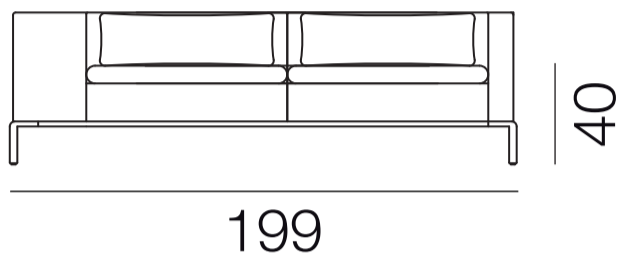

/90

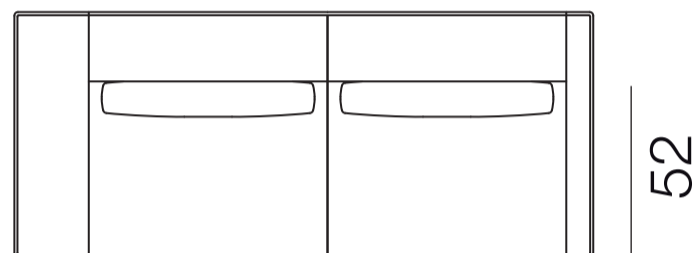
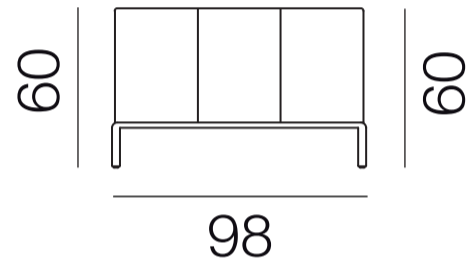
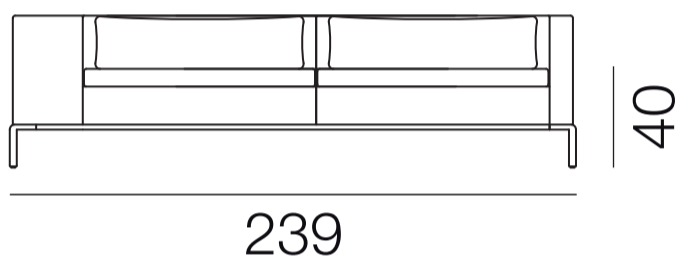

Hocker / Stool

/05

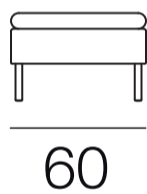
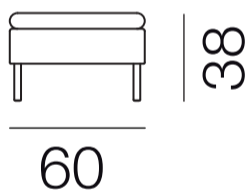

/35

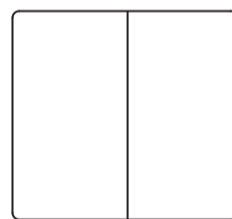
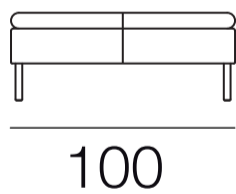
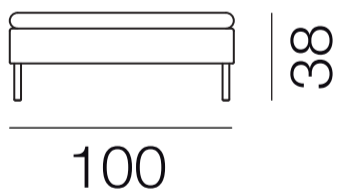

/45

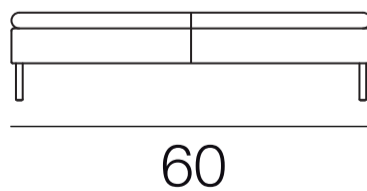
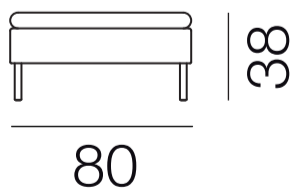

Kissen / Cushions

/98

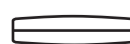
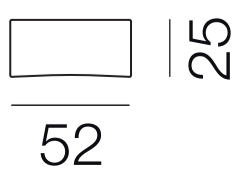

/Armchair

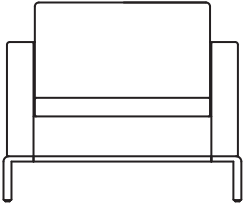

88

40

78

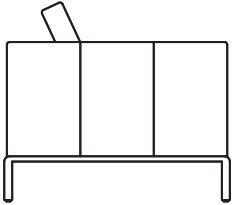

87

60

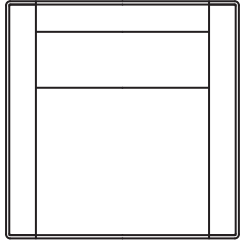

52

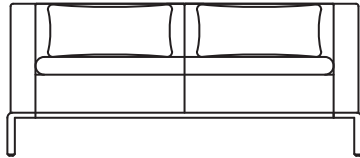

143

40

60

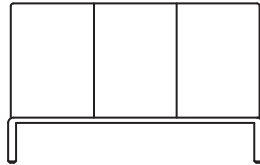

98

60

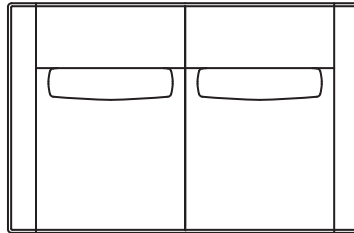

52

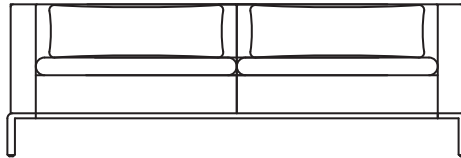

183

40

60



98

60

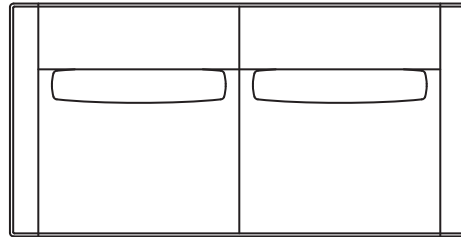

52

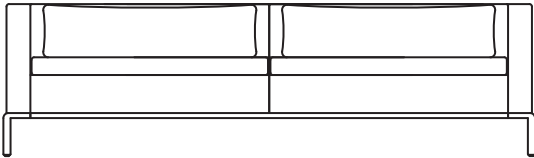

223

40

60



98

60

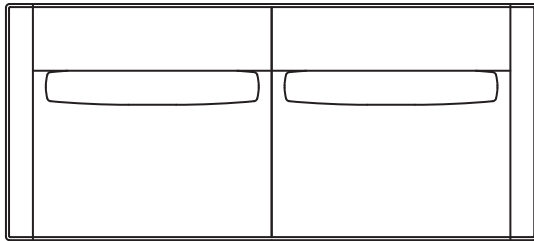

50

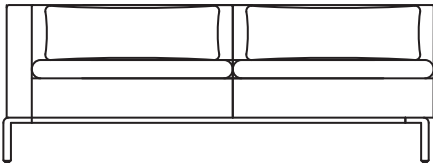

171

40

60



98

60

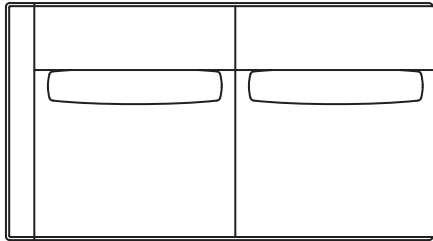

52

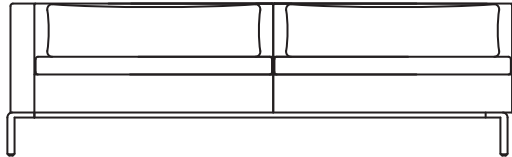

211

40

60

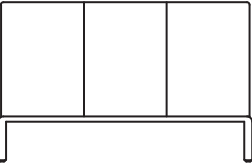

98

60

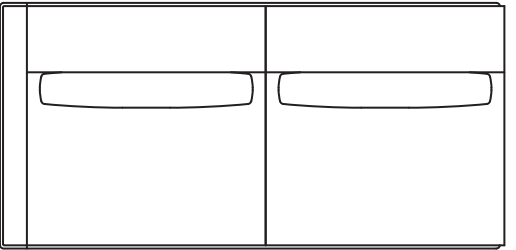

52

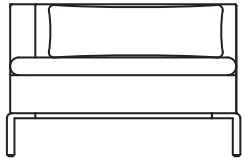

40

94

60

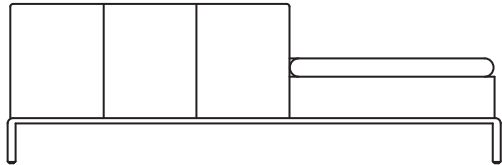

198

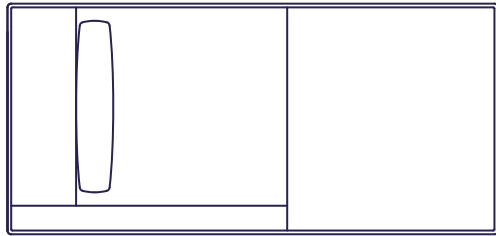

152

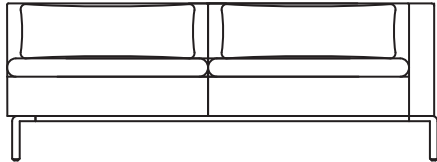

171

40

60

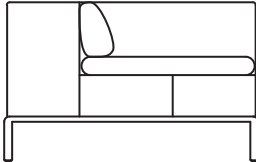

98

60

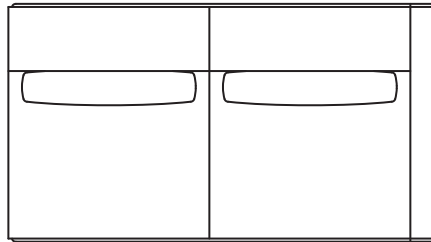

52

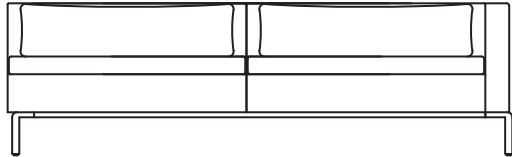

211

40

60

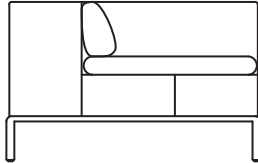

98

60

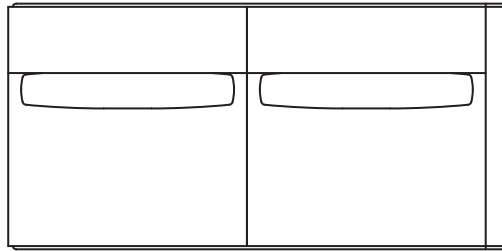

52

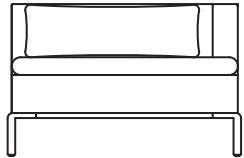

94

40

60

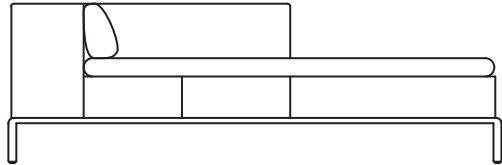

198

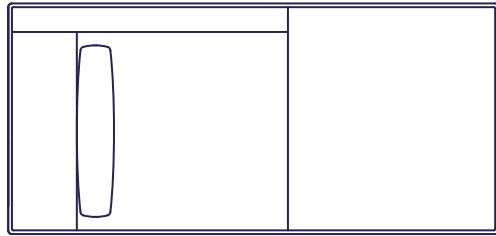

152

elemente / End elements

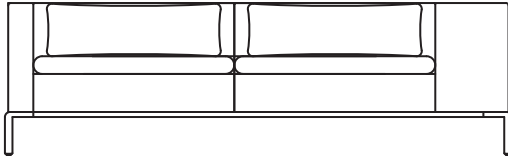

199

40

60

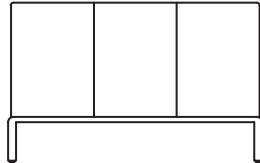

98

60

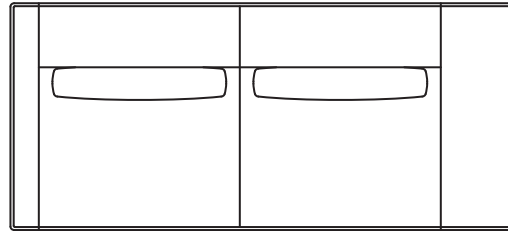

52

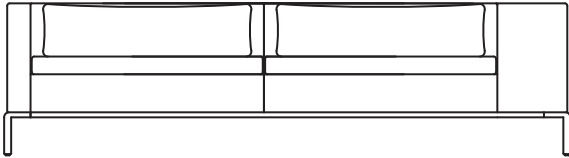

239

40

60

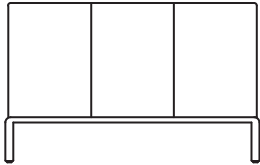

98

60

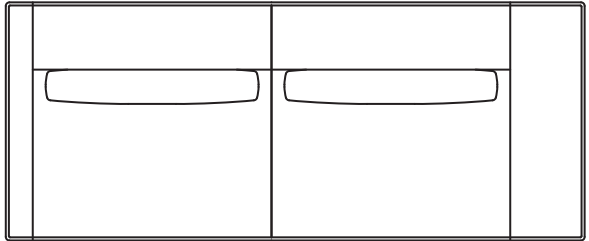

52

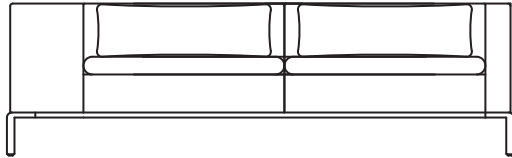

199

40

60

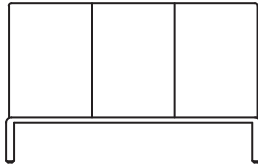

98

60

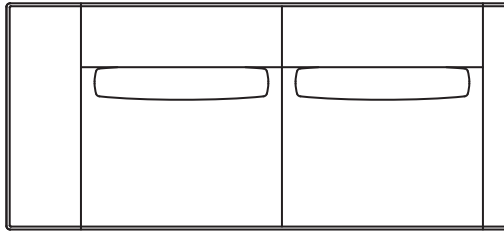

52

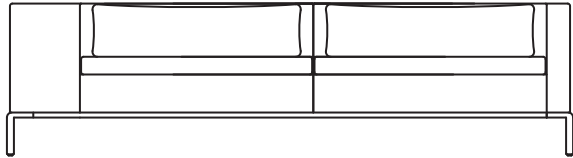

239

40

60

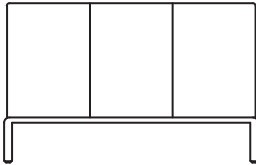

98

60

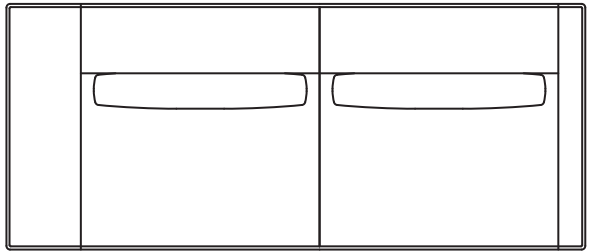

52

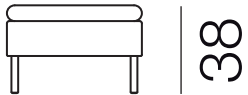

38

60

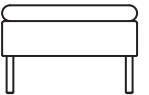

60

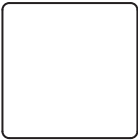

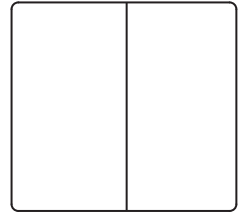
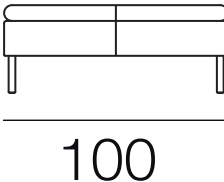
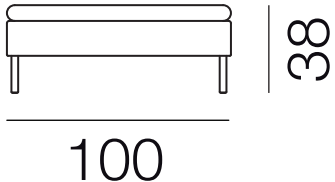

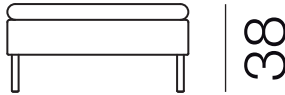

80

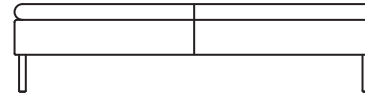

60

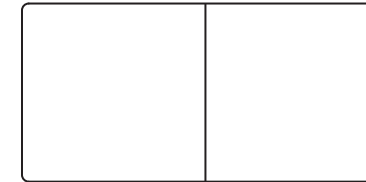

$$\frac{\square}{52} = 25$$

$$\frac{\text{rod}}{12}$$

