

Zwischenelemente / Intermediate elements

/07			
/17			
/37			

Eckelemente / Corner elements

/08			
/18			
/28			

Abschlusselement / End element

/09			
/10			
/19			
/20			

Recamiera / Recamier

/59			
/60			

Abschlusselement ohne Armlehne / End element without armrest

/39			
/40			

Abschlusselement tief ohne Armlehne / End element low without armrest

/79			
/80			
/89			
/90			

Hocker / Stool

/05			
/15			
/25			

## Zwischenelemente / Intermediate elements

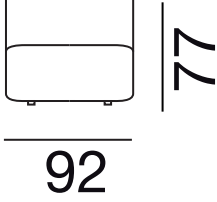
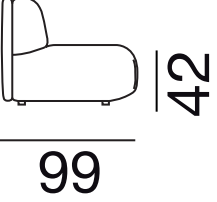
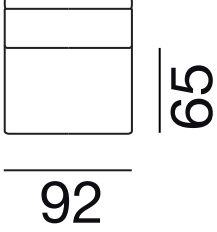
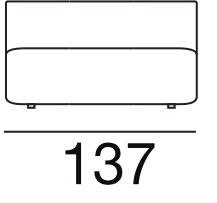
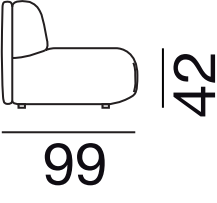
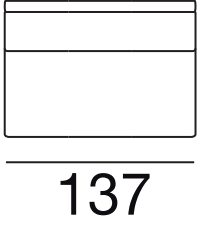
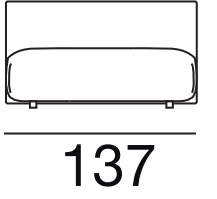
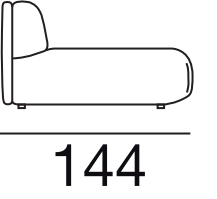
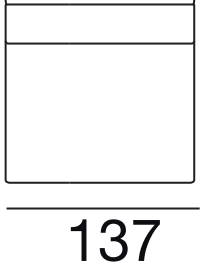
/07	 92 77	 99 42	 92 65
/17	 137 77	 99 42	 137 65
/37	 137 77	 144 42	 137 110

## Eckelemente / Corner elements

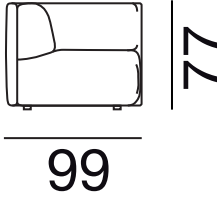
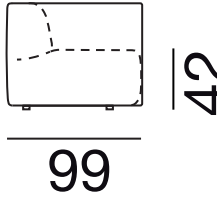
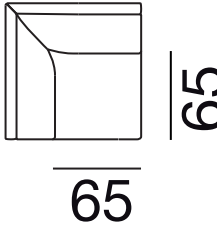
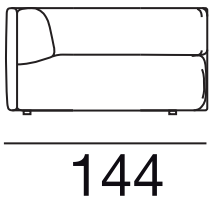
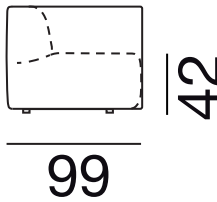
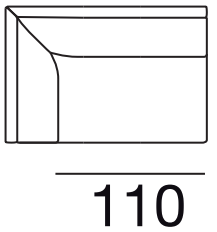
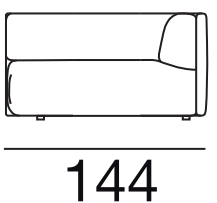
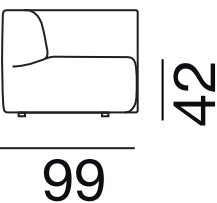
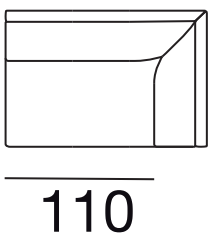
/08	 99 77	 99 42	 65 65
/18	 144 77	 99 42	 110 65
/28	 144 77	 99 42	 110 65

## Abschlusselement / End element

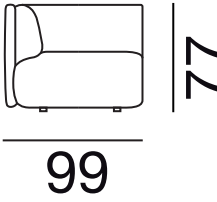
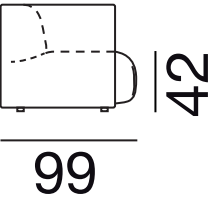
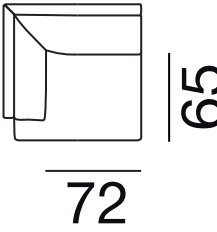
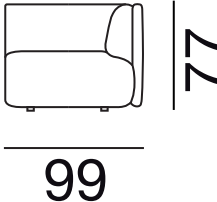
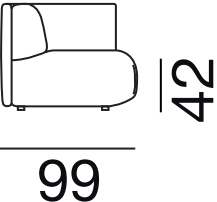
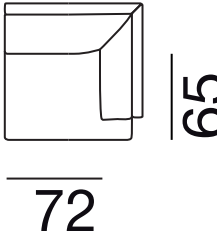
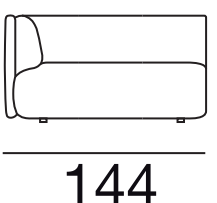
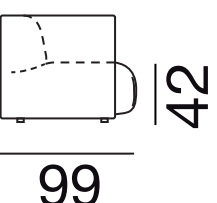
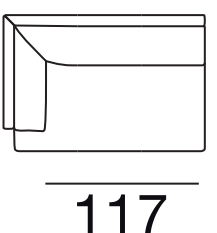
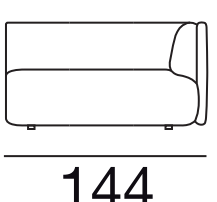
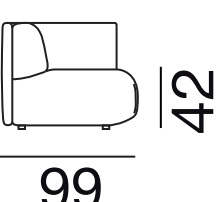
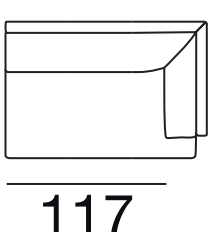
/09	 99 77	 99 42	 72 65
/10	 99 77	 99 42	 72 65
/19	 144 77	 99 42	 117 65
/20	 144 77	 99 42	 117 65

# Recamiere / Recamier

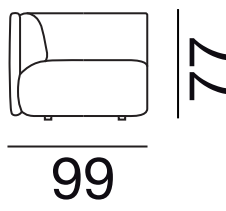
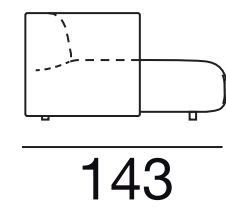
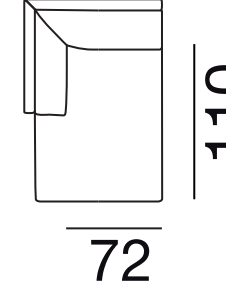
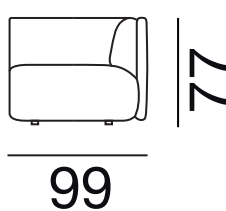
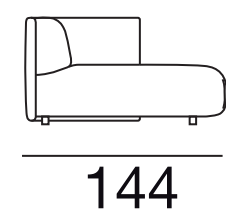
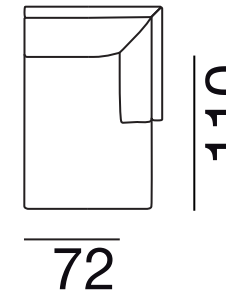
/59	 99 77	 143 42	 72 110
/60	 99 77	 144 42	 72 110

## Abschlusselement ohne Armlehne / End element without armrest

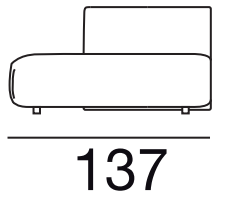
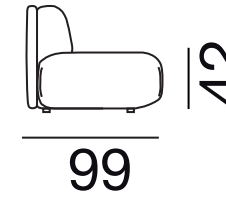
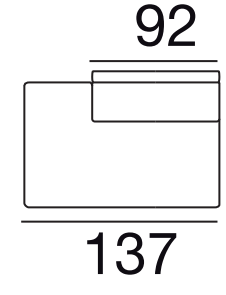
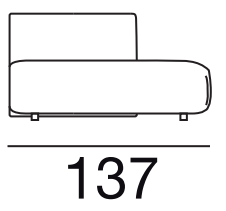
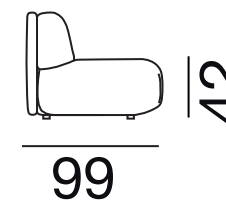
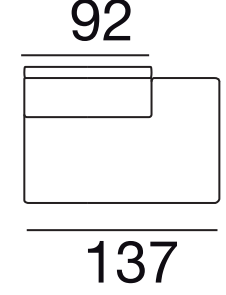
/39	 137 77	 99 42	 92 137 65
/40	 137 77	 99 42	 92 65 137 92

## Abschlusselement tief ohne Armlehne / End element low without armrest

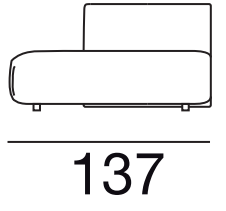
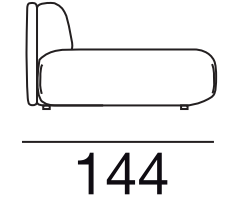
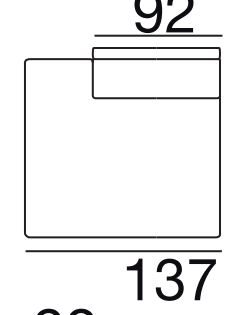
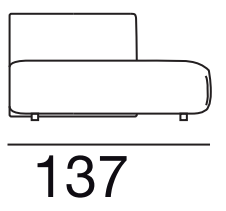
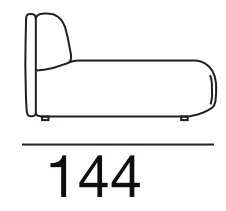
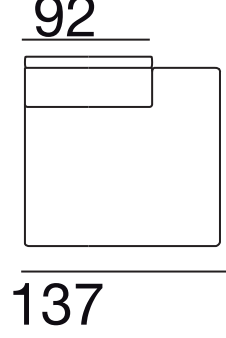
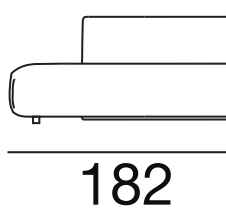
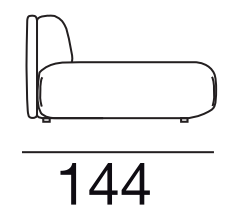
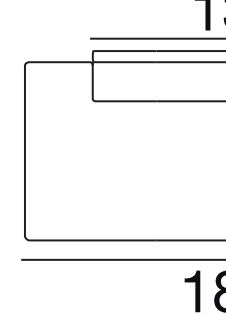
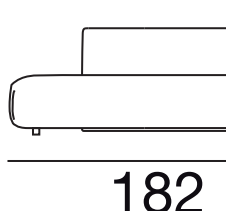
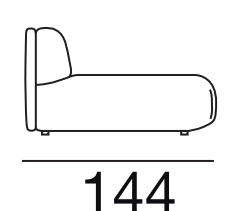
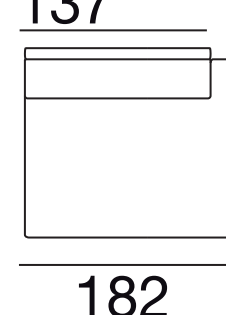
/79	 137 77	 144 42	 92 137 110
/80	 137 77	 144 42	 92 137 137
/89	 182 77	 144 42	 137 182 110
/90	 182 77	 144 42	 137 182 137

## Hocker / Stool

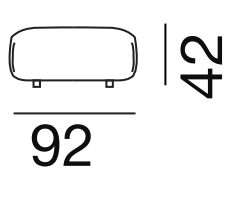
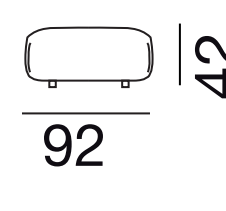
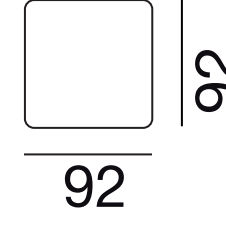
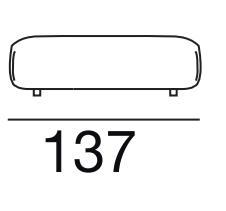
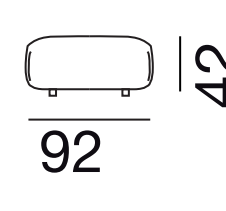
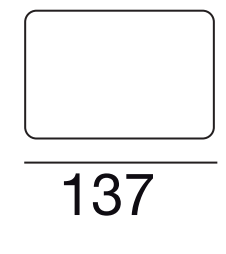
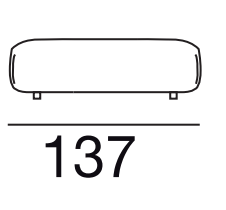
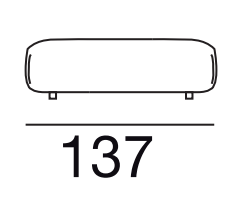
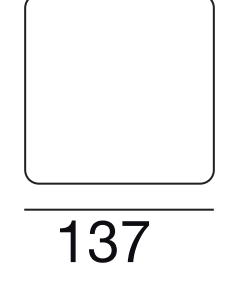
/05	 92 42	 92 42	 92 92
/15	 137 42	 92 42	 137 92
/25	 137 42	 137 42	 137 137

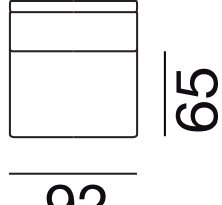
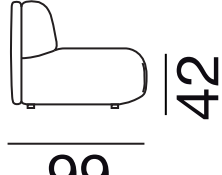

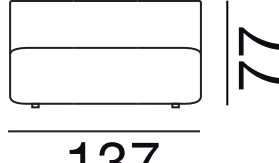

92

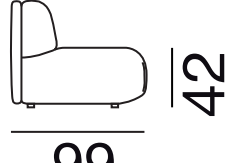

99

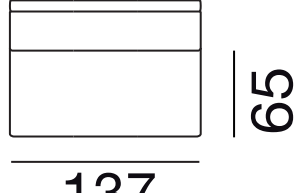

92

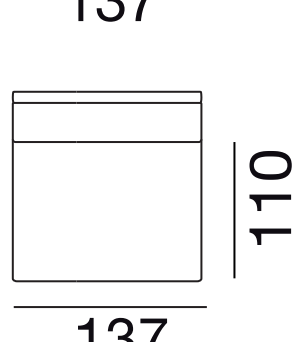
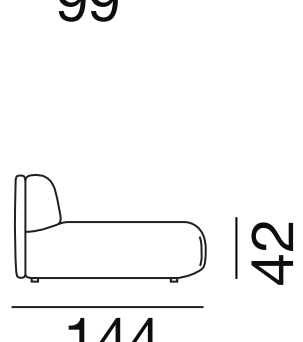
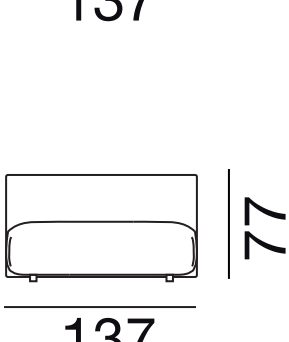

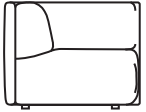

77

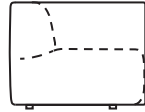

42

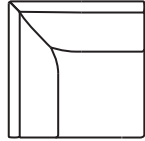

65

88

88

65

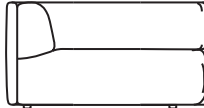
$$\frac{144}{77} = 99$$

A diagram of a cylinder with a top flap. The top flap is shown as a curved surface extending from the top edge of the cylinder. The cylinder has a horizontal line across its middle, and small rectangular feet at the bottom.

$$\frac{99}{42} = 99$$

A diagram of a cylinder with a dashed top flap. The top flap is shown as a dashed line extending from the top edge of the cylinder. The cylinder has a horizontal line across its middle, and small rectangular feet at the bottom.

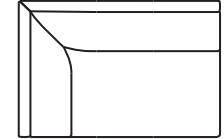
$$\frac{110}{65} = 65$$

A diagram of a cylinder with a top flap. The top flap is shown as a curved surface extending from the top edge of the cylinder. The cylinder has a horizontal line across its middle, and small rectangular feet at the bottom.



144

99

110

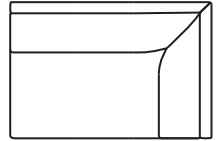
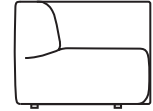
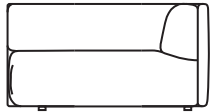

144

99

110

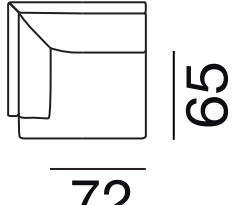
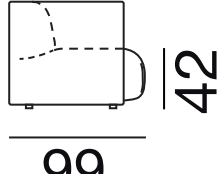
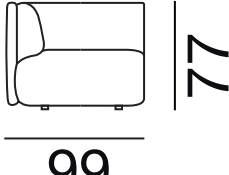

99

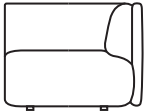

77

99

99

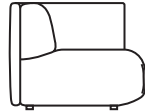

42

99

72

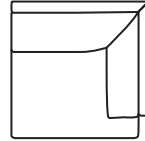

65

72

33

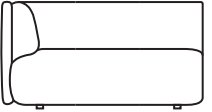

77

144

33

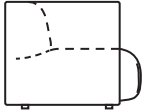

42

99

12

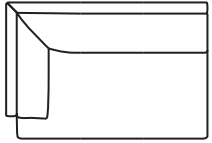

65

117

144

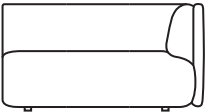

77

144

99



42

99

117

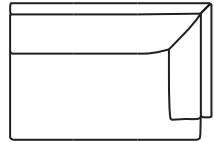

65

117

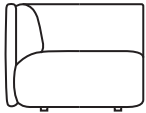

77

88

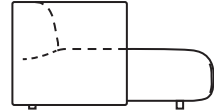

42

142

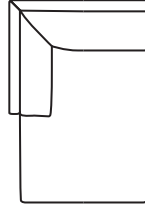

110

72

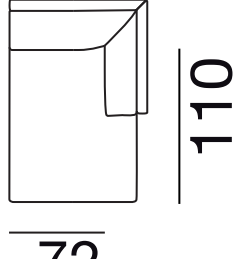
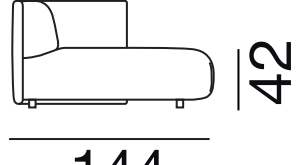

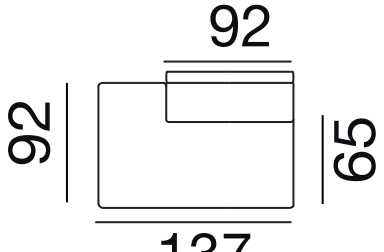
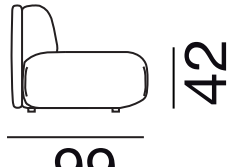
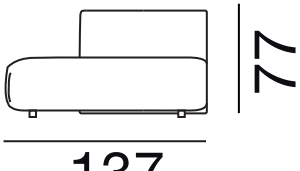



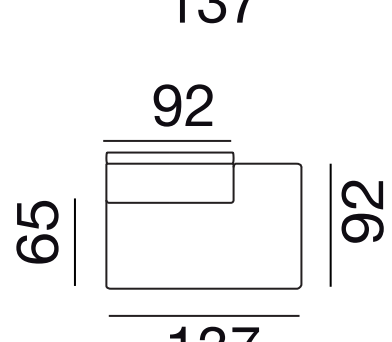
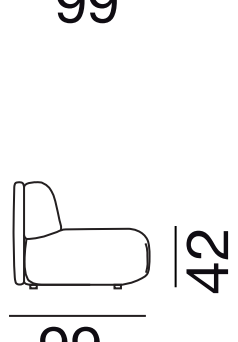
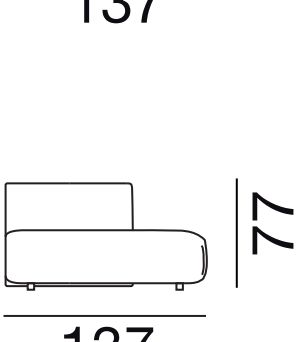

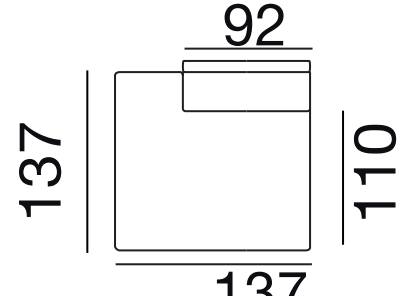
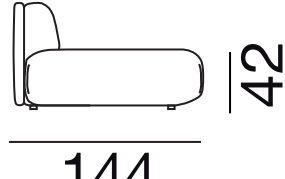
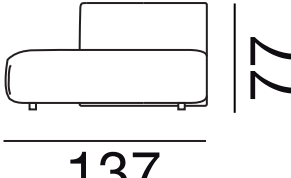

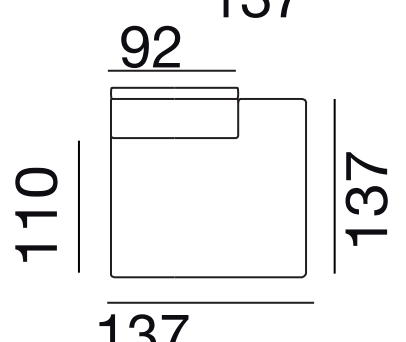
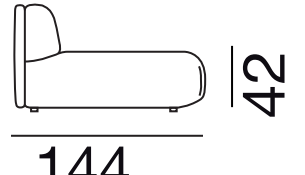
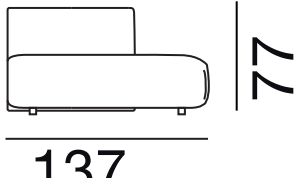

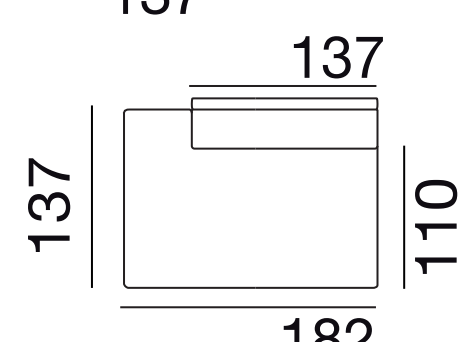
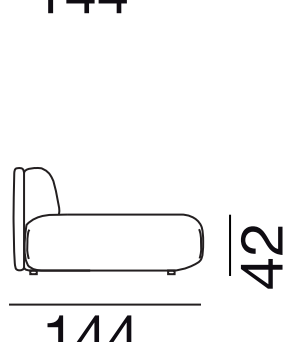
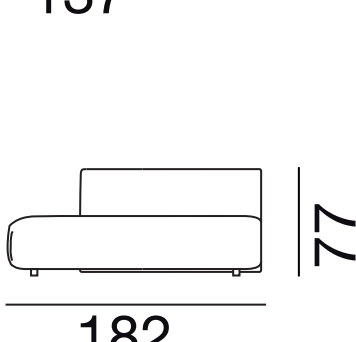

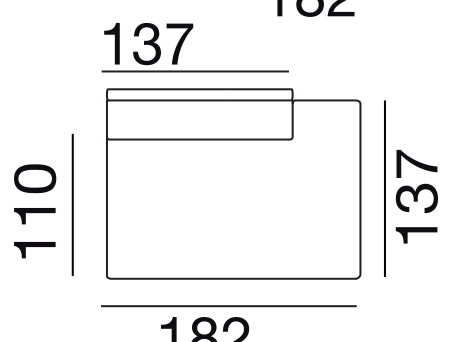
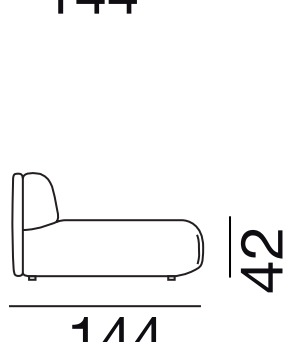
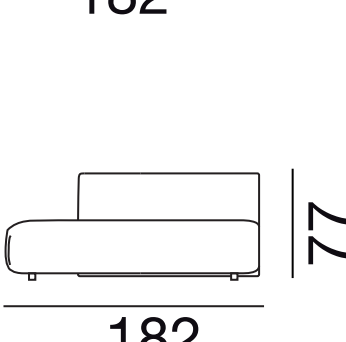

$$\frac{33}{42}$$

$$\frac{33}{42}$$

$$\frac{33}{92}$$



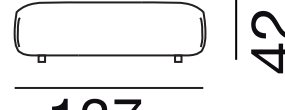

137

92

137